

LP3893

3A Fast-Response Ultra Low Dropout Linear Regulators

General Description

The LP3893 is a high-current, fast-response regulator which can maintain output voltage regulation with minimum input to output voltage drop. Fabricated on a CMOS process, the device operates from two input voltages: Vbias provides voltage to drive the gate of the N-MOS power transistor, while Vin is the input voltage which supplies power to the load. The use of an external bias rail allows the part to operate from ultra low Vin voltages. Unlike bipolar regulators, the CMOS architecture consumes extremely low quiescent current at any output load current. The use of an N-MOS power transistor results in wide bandwidth, yet minimum external capacitance is required to maintain loop stability.

The fast transient response of these devices makes them suitable for use in powering DSP, Microcontroller Core voltages and Switch Mode Power Supply post regulators. The parts are available in TO-220 and TO-263 packages.

Dropout Voltage: 270 mV (typ) @ 3A load current.

Ground Pin Current: 3 mA (typ) at full load.

Shutdown Current: 60 nA (typ) when S/D pin is low.

Precision Output Voltage: 1.5% room temperature accuracy.

Features

- Ultra low dropout voltage (270 mV @ 3A typ)
- Low ground pin current
- Load regulation of 0.04%/A
- 60 nA typical quiescent current in shutdown
- 1.5% output accuracy (25°C)
- TO-220, TO-263 packages
- Over temperature/over current protection
- -40°C to +125°C junction temperature range

Applications

- DSP Power Supplies
- Server Core and I/O Supplies
- Linear Power Supplies for PC Add-in-Cards
- Set-Top Box Power Supplies
- Microprocessor Power Supplies
- High Efficiency Linear Power Supplies
- SMPS Post-Regulators

Typical Application Circuit

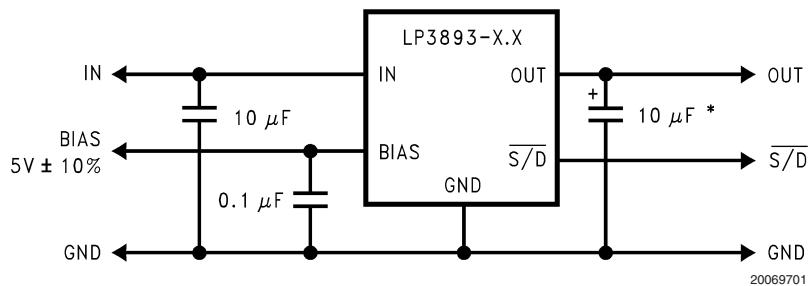

At least 10 µF of input and output capacitance is required for stability.

*Tantalum capacitors are recommended. Aluminum electrolytic capacitors may be used for restricted temperature range. See application hints.

Connection Diagrams

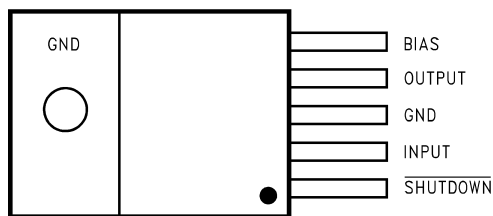

TO-220, Top View

20069702

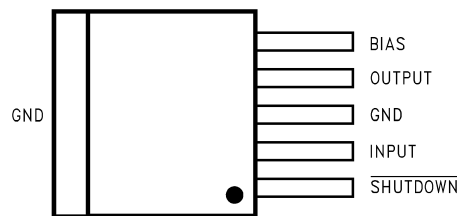

TO-263, Top View

20069703

Ordering Information

Order Number	Package Type	Package Drawing	Supplied As
LP3893ES-1.2	TO263-5	TS5B	Rail
LP3893ESX-1.2	TO263-5	TS5B	Tape and Reel
LP3893ET-1.2	TO220-5	T05D	Rail
LP3893ES-1.5	TO263-5	TS5B	Rail
LP3893ESX-1.5	TO263-5	TS5B	Tape and Reel
LP3893ET-1.5	TO220-5	T05D	Rail
LP3893ES-1.8	TO263-5	TS5B	Rail
LP3893ESX-1.8	TO263-5	TS5B	Tape and Reel
LP3893ET-1.8	TO220-5	T05D	Rail

Block Diagram

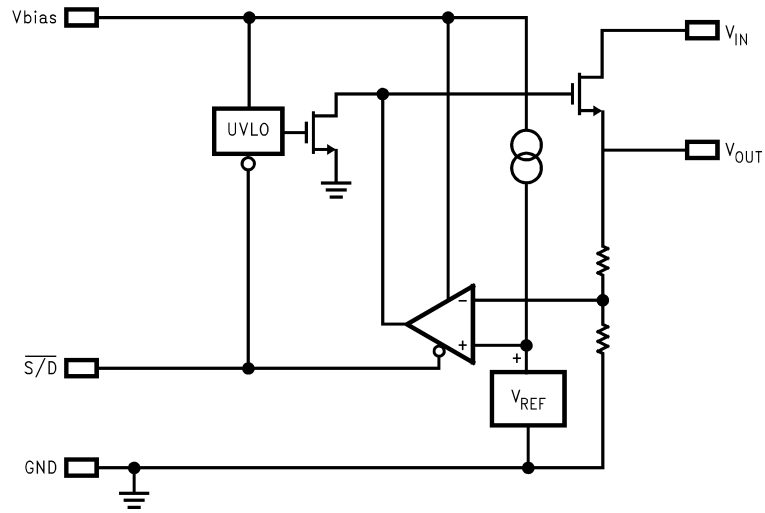

20069724

Absolute Maximum Ratings (Note 1)

If Military/Aerospace specified devices are required, please contact the National Semiconductor Sales Office/Distributors for availability and specifications.

Storage Temperature Range	-65°C to +150°C
Lead Temp. (Soldering, 5 seconds)	260°C
ESD Rating	
Human Body Model (Note 3)	2 kV
Machine Model (Note 10)	200V
Power Dissipation (Note 2)	Internally Limited
V _{IN} Supply Voltage (Survival)	-0.3V to +6V
V _{BIAS} Supply Voltage (Survival)	-0.3V to +7V

Shutdown Input Voltage (Survival)	-0.3V to +7V
I _{OUT} (Survival)	Internally Limited
Output Voltage (Survival)	-0.3V to +6V
Junction Temperature	-40°C to +150°C

Operating Ratings

V _{IN}	(V _{OUT} + V _{DO}) to 5.5V
Shutdown	0 to +6V
I _{OUT}	3A
Junction Temperature	-40°C to +125°C
V _{BIAS}	4.5V to 6V

Electrical Characteristics Limits in standard typeface are for T_J = 25°C, and limits in **boldface type** apply over the full operating temperature range. Unless otherwise specified: V_{IN} = V_{O(NOM)} + 1V, V_{BIAS} = 4.5V, I_L = 10 mA, C_{IN} = C_{OUT} = 10 μF, V_{S/D} = V_{BIAS}.

Symbol	Parameter	Conditions	Typical (Note 4)	MIN (Note 5)	MAX (Note 5)	Units
V _O	Output Voltage Tolerance	10 mA ≤ I _L ≤ 3A V _{O(NOM)} + 1V ≤ V _{IN} ≤ 5.5V 4.5V ≤ V _{BIAS} ≤ 6V	1.216	1.198	1.234	V
			1.5	1.478	1.522	
			1.8	1.773	1.827	
				1.186	1.246	
				1.455	1.545	
				1.746	1.854	
ΔV _O /ΔV _{IN}	Output Voltage Line Regulation (Note 7)	V _{O(NOM)} + 1V ≤ V _{IN} ≤ 5.5V	0.01			%/V
ΔV _O /ΔI _L	Output Voltage Load Regulation (Note 8)	10 mA ≤ I _L ≤ 3A	0.04 0.06			%/A
V _{DO}	Dropout Voltage (Note 9)	I _L = 3A	270		650 1000	mV
I _Q (V _{IN})	Quiescent Current Drawn from V _{IN} Supply	10 mA ≤ I _L ≤ 3A	3		7 8	mA
		V _{S/D} ≤ 0.3V	0.03		1 30	μA
I _Q (V _{BIAS})	Quiescent Current Drawn from V _{BIAS} Supply	10 mA ≤ I _L ≤ 3A	1		2 3	mA
		V _{S/D} ≤ 0.3V	0.03		1 30	μA
I _{SC}	Short-Circuit Current	V _{OUT} = 0V	6			A
Shutdown Input						
V _{SDT}	Output Turn-off Threshold	Output = ON	0.7	1.3		V
		Output = OFF	0.7		0.3	
Td (OFF)	Turn-OFF Delay	R _{LOAD} X C _{OUT} << Td (OFF)	20			μs
Td (ON)	Turn-ON Delay	R _{LOAD} X C _{OUT} << Td (ON)	15			
I _{S/D}	S/D Input Current	V _{S/D} = 1.3V	1			μA
		V _{S/D} ≤ 0.3V	-1			

Electrical Characteristics Limits in standard typeface are for $T_J = 25^\circ\text{C}$, and limits in **boldface type** apply over the full operating temperature range. Unless otherwise specified: $V_{IN} = V_O(\text{NOM}) + 1\text{V}$, $V_{BIAS} = 4.5\text{V}$, $I_L = 10\text{ mA}$, $C_{IN} = C_{OUT} = 10\text{ }\mu\text{F}$, $V_{S/D} = V_{BIAS}$. (Continued)

Symbol	Parameter	Conditions	Typical (Note 4)	MIN (Note 5)	MAX (Note 5)	Units
AC Parameters						
PSRR (V_{IN})	Ripple Rejection for V_{IN} Input Voltage	$V_{IN} = V_{OUT} + 1\text{V}$, $f = 120\text{ Hz}$	80			dB
		$V_{IN} = V_{OUT} + 1\text{V}$, $f = 1\text{ kHz}$	65			
PSRR (V_{BIAS})	Ripple Rejection for V_{BIAS} Voltage	$V_{BIAS} = V_{OUT} + 3\text{V}$, $f = 120\text{ Hz}$	70			dB
		$V_{BIAS} = V_{OUT} + 3\text{V}$, $f = 1\text{ kHz}$	65			
	Output Noise Density	$f = 120\text{ Hz}$	1			$\mu\text{V}/\text{root-Hz}$
e_n	Output Noise Voltage	$\text{BW} = 10\text{ Hz} - 100\text{ kHz}$, $V_{OUT} = 1.8\text{V}$	150			$\mu\text{V (rms)}$
		$\text{BW} = 300\text{ Hz} - 300\text{ kHz}$, $V_{OUT} = 1.8\text{V}$	90			

Note 1: Absolute maximum ratings indicate limits beyond which damage to the component may occur. Operating ratings indicate conditions for which the device is intended to be functional, but do not guarantee specific performance limits. For guaranteed specifications, see Electrical Characteristics. Specifications do not apply when operating the device outside of its rated operating conditions.

Note 2: At elevated temperatures, device power dissipation must be derated based on package thermal resistance and heatsink thermal values. θ_{JA} for TO-220 devices is 65°C/W if no heatsink is used. If the TO-220 device is attached to a heatsink, a θ_{JS} value of 4°C/W can be assumed. θ_{JA} for TO-263 devices is approximately 40°C/W if soldered down to a copper plane which is at least 1.5 square inches in area. If power dissipation causes the junction temperature to exceed specified limits, the device will go into thermal shutdown.

Note 3: The human body model is a 100 pF capacitor discharged through a 1.5k resistor into each pin.

Note 4: Typical numbers represent the most likely parametric norm for 25°C operation.

Note 5: Limits are guaranteed through testing, statistical correlation, or design.

Note 6: If used in a dual-supply system where the regulator load is returned to a negative supply, the output pin must be diode clamped to ground.

Note 7: Output voltage line regulation is defined as the change in output voltage from nominal value resulting from a change in input voltage.

Note 8: Output voltage load regulation is defined as the change in output voltage from nominal value as the load current increases from no load to full load.

Note 9: Dropout voltage is defined as the minimum input to output differential required to maintain the output with 2% of nominal value.

Note 10: The machine model is a 220 pF capacitor discharged directly into each pin. The machine model ESD rating of pin 5 is 100V.

Typical Performance Characteristics

Unless otherwise specified: $T_j = 25^\circ\text{C}$, $C_{OUT} = 10\ \mu\text{F}$, $C_{in} = 10\ \mu\text{F}$, S/D pin is tied to V_{BIAS} , $V_{IN} = 2.2\text{V}$, $V_{OUT} = 1.8\text{V}$.

μF , S/D pin is tied to V_{BIAS} , $V_{IN} = 2.2\text{V}$, $V_{OUT} = 1.8\text{V}$.

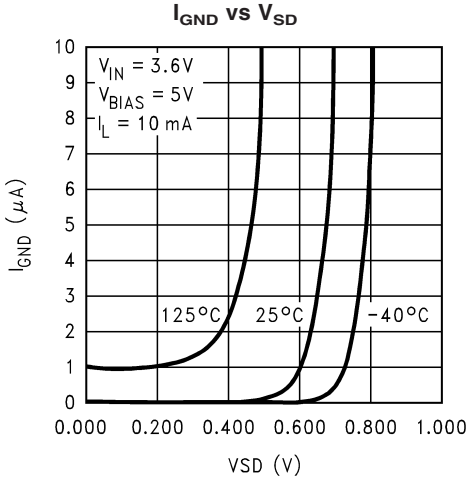

20069705

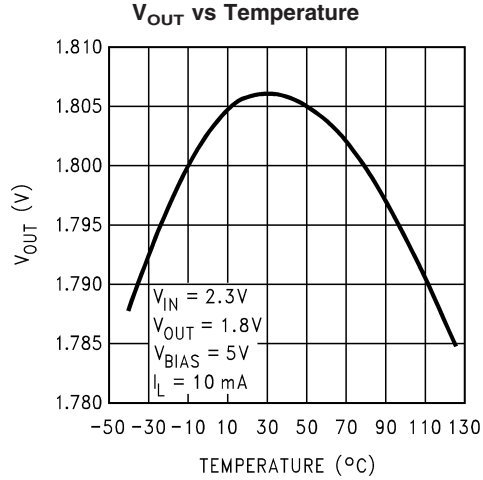

20069706

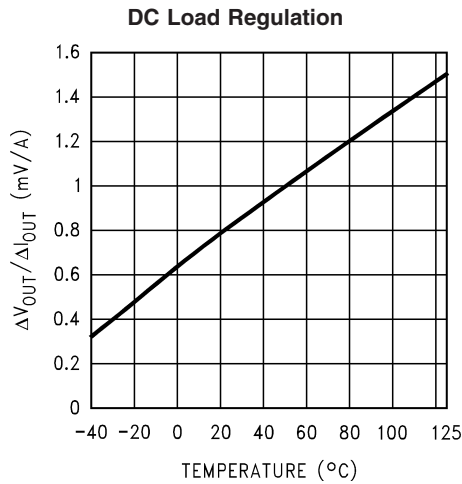

20069707

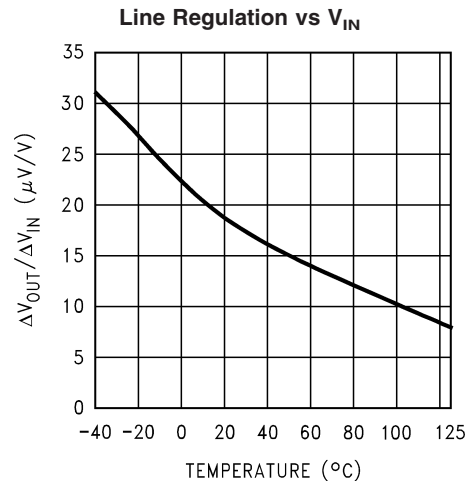

20069708

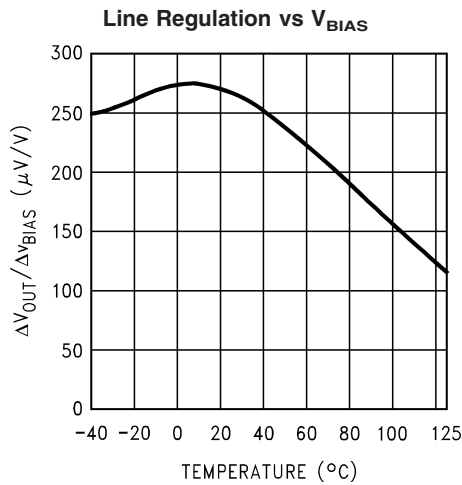

20069709

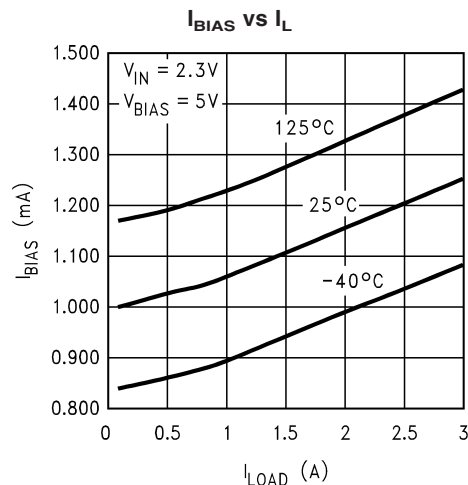

20069710

Typical Performance Characteristics Unless otherwise specified: $T_j = 25^\circ\text{C}$, $C_{OUT} = 10\ \mu\text{F}$, $C_{in} = 10\ \mu\text{F}$, $\overline{\text{S/D}}$ pin is tied to V_{BIAS} , $V_{IN} = 2.2\text{V}$, $V_{OUT} = 1.8\text{V}$. (Continued)

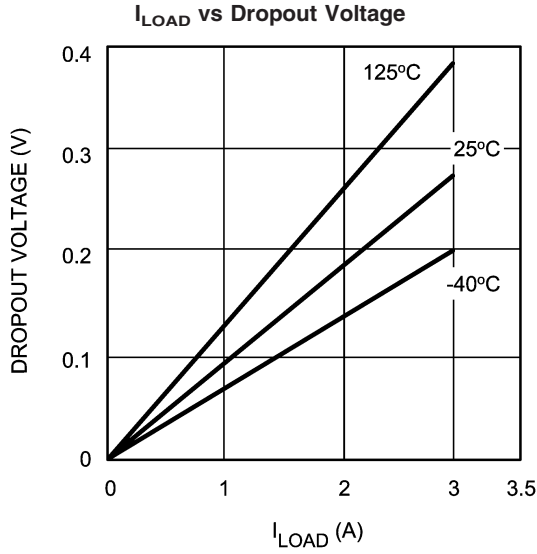

20069732

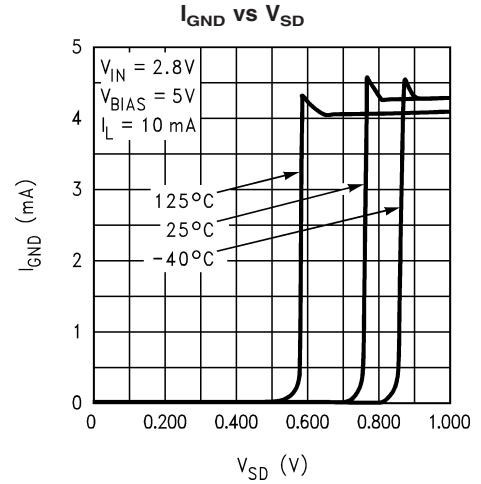

20069712

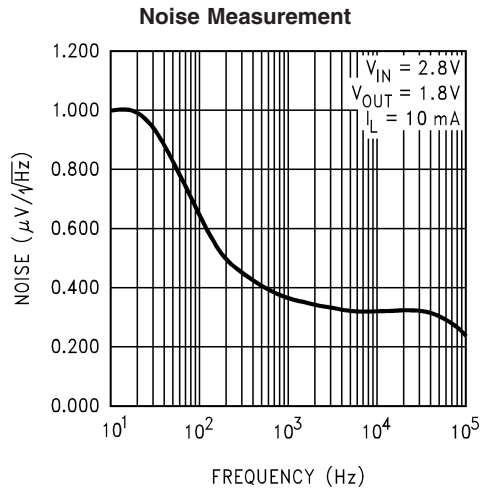

20069714

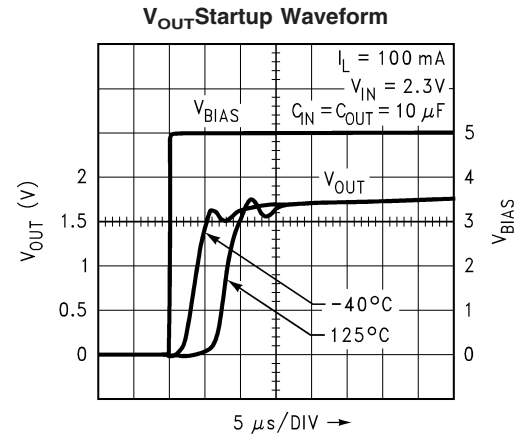

20069715

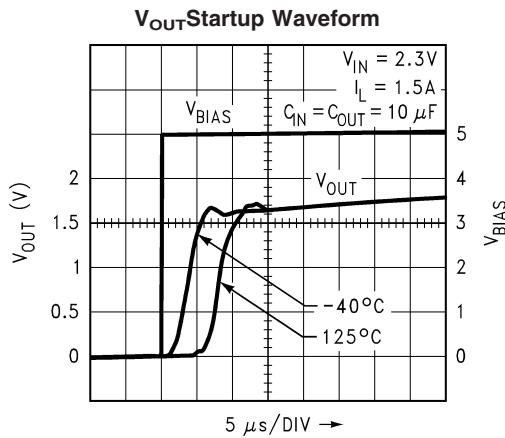

20069716

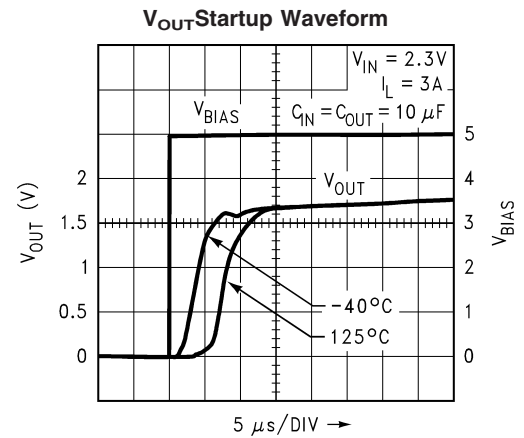

20069717

Typical Performance Characteristics Unless otherwise specified: $T_j = 25^\circ\text{C}$, $C_{OUT} = 10\ \mu\text{F}$, $C_{in} = 10\ \mu\text{F}$, $\overline{\text{S/D}}$ pin is tied to V_{BIAS} , $V_{IN} = 2.2\text{V}$, $V_{OUT} = 1.8\text{V}$. (Continued)

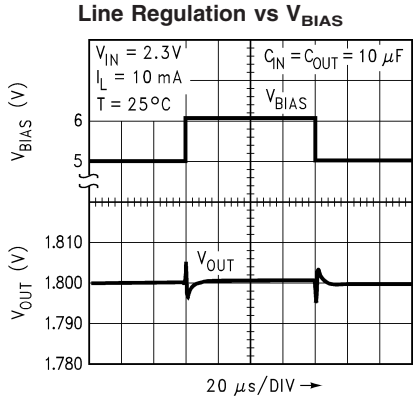

20069718

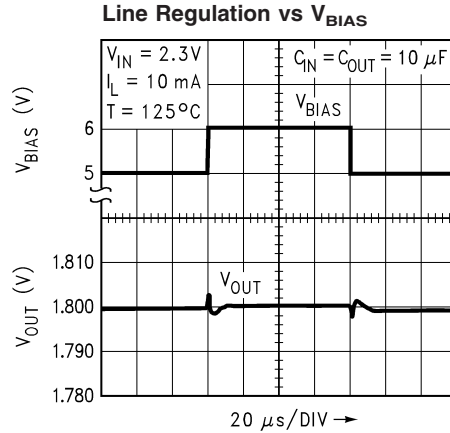

20069719

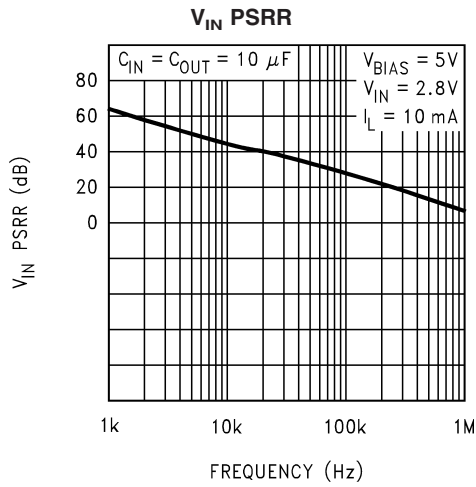

20069720

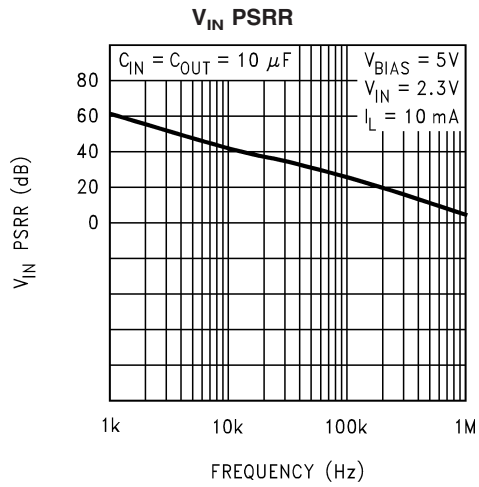

20069723

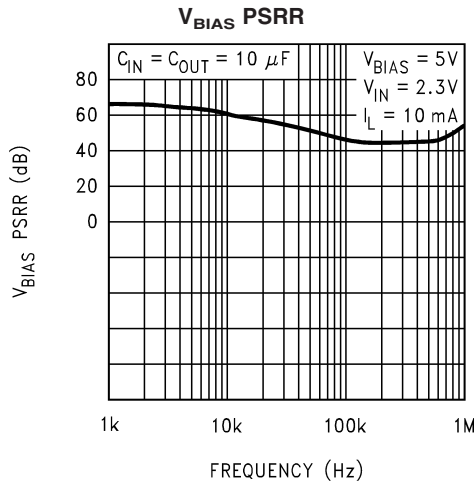

20069722

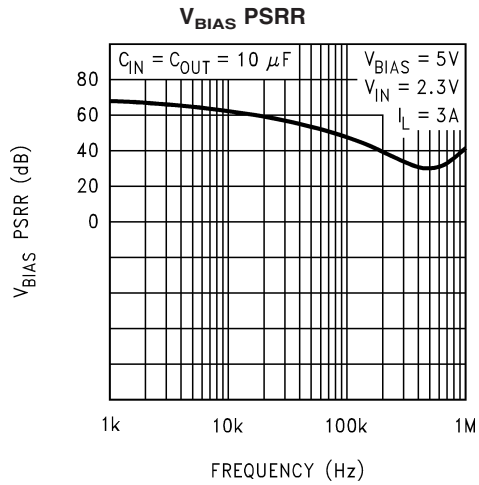

20069721

Application Hints

EXTERNAL CAPACITORS

To assure regulator stability, input and output capacitors are required as shown in the Typical Application Circuit.

OUTPUT CAPACITOR

At least 10 μ F of output capacitance is required for stability (the amount of capacitance can be increased without limit). The output capacitor must be located less than 1 cm from the output pin of the IC and returned to a clean analog ground. The ESR (equivalent series resistance) of the output capacitor must be within the "stable" range as shown in the graph below over the full operating temperature range for stable operation.

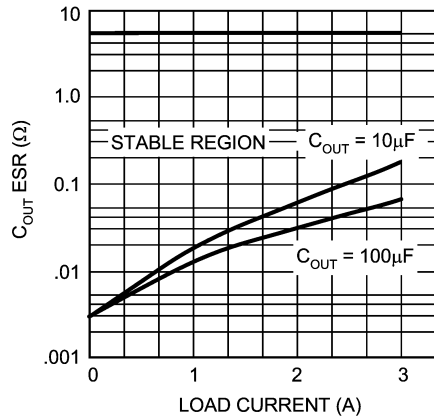

Minimum ESR vs Output Load Current

Tantalum capacitors are recommended for the output as their ESR is ideally suited to the part's requirements and the ESR is very stable over temperature. Aluminum electrolytics are not recommended because their ESR increases very rapidly at temperatures below 10°C. Aluminum caps can only be used in applications where lower temperature operation is not required.

A second problem with Al caps is that many have ESR's which are only specified at low frequencies. The typical loop bandwidth of a linear regulator is a few hundred kHz to several MHz. If an Al cap is used for the output cap, it must be one whose ESR is specified at a frequency of 100 kHz or more.

Because the ESR of ceramic capacitors is only a few milli Ohms, they are not suitable for use as output capacitors on LP389X devices. The regulator output can tolerate ceramic capacitance totaling up to 15% of the amount of Tantalum capacitance connected from the output to ground.

INPUT CAPACITOR

The input capacitor must be at least 10 μ F, but can be increased without limit. Its purpose is to provide a low source impedance for the regulator input. Ceramic capacitors work best for this, but Tantalums are also very good. There is no ESR limitation on the input capacitor (the lower, the better). Aluminum electrolytics can be used, but their ESR increase very quickly at cold temperatures. They are not recommended for any application where temperatures go below about 10°C.

BIAS CAPACITOR

The 0.1 μ F capacitor on the bias line can be any good quality capacitor (ceramic is recommended).

BIAS VOLTAGE

The bias voltage is an external voltage rail required to get gate drive for the N-FET pass transistor. Bias voltage must be in the range of 4.5 - 6V to assure proper operation of the part.

UNDER VOLTAGE LOCKOUT

The bias voltage is monitored by a circuit which prevents the regulator output from turning on if the bias voltage is below approximately 4V.

SHUTDOWN OPERATION

Pulling down the shutdown ($\overline{S/D}$) pin will turn-off the regulator. Pin $\overline{S/D}$ must be actively terminated through a pull-up resistor (10 k Ω to 100 k Ω) for a proper operation. If this pin is driven from a source that actively pulls high and low (such as a CMOS rail to rail comparator), the pull-up resistor is not required. This pin must be tied to V_{in} if not used.

POWER DISSIPATION/HEATSINKING

A heatsink may be required depending on the maximum power dissipation and maximum ambient temperature of the application. Under all possible conditions, the junction temperature must be within the range specified under operating conditions. The total power dissipation of the device is given by:

$$P_D = (V_{IN} - V_{OUT})I_{OUT} + (V_{IN})I_{GND}$$

where I_{GND} is the operating ground current of the device.

The maximum allowable temperature rise (T_{Rmax}) depends on the maximum ambient temperature (T_{Amax}) of the application, and the maximum allowable junction temperature (T_{Jmax}):

$$T_{Rmax} = T_{Jmax} - T_{Amax}$$

The maximum allowable value for junction to ambient Thermal Resistance, θ_{JA} , can be calculated using the formula:

$$\theta_{JA} = T_{Rmax} / P_D$$

These parts are available in TO-220 and TO-263 packages. The thermal resistance depends on amount of copper area or heat sink, and on air flow. If the maximum allowable value of θ_{JA} calculated above is ≥ 60 °C/W for TO-220 package and ≥ 60 °C/W for TO-263 package no heatsink is needed since the package can dissipate enough heat to satisfy these requirements. If the value for allowable θ_{JA} falls below these limits, a heat sink is required.

HEATSINKING TO-220 PACKAGE

The thermal resistance of a TO220 package can be reduced by attaching it to a heat sink or a copper plane on a PC board. If a copper plane is to be used, the values of θ_{JA} will be same as shown in next section for TO263 package.

The heatsink to be used in the application should have a heatsink to ambient thermal resistance,

$$\theta_{HA} \leq \theta_{JA} - \theta_{CH} - \theta_{JC}$$

In this equation, θ_{CH} is the thermal resistance from the case to the surface of the heat sink and θ_{JC} is the thermal resistance from the junction to the surface of the case. θ_{JC} is about 3°C/W for a TO220 package. The value for θ_{CH} depends on method of attachment, insulator, etc. θ_{CH} varies between 1.5°C/W to 2.5°C/W. If the exact value is unknown, 2°C/W can be assumed.

Application Hints (Continued)

HEATSINKING TO-263 PACKAGE

The TO-263 package uses the copper plane on the PCB as a heatsink. The tab of these packages are soldered to the copper plane for heat sinking. The graph below shows a curve for the θ_{JA} of TO-263 package for different copper area sizes, using a typical PCB with 1 ounce copper and no solder mask over the copper area for heat sinking.

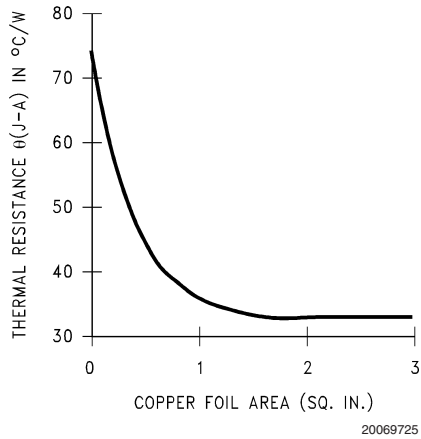

FIGURE 1. θ_{JA} vs Copper (1 Ounce) Area for TO-263 package

As shown in the graph below, increasing the copper area beyond 1 square inch produces very little improvement. The minimum value for θ_{JA} for the TO-263 package mounted to a PCB is 32 $^{\circ}\text{C}/\text{W}$.

Figure 2 shows the maximum allowable power dissipation for TO-263 packages for different ambient temperatures, assuming θ_{JA} is 35 $^{\circ}\text{C}/\text{W}$ and the maximum junction temperature is 125 $^{\circ}\text{C}$.

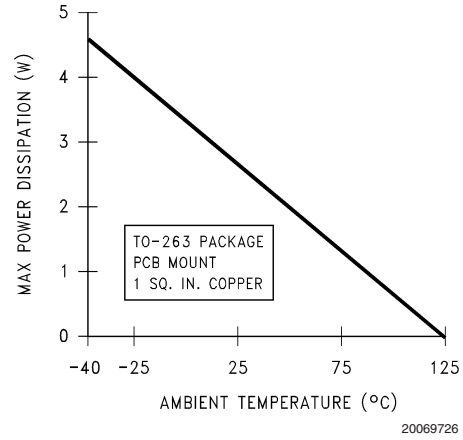
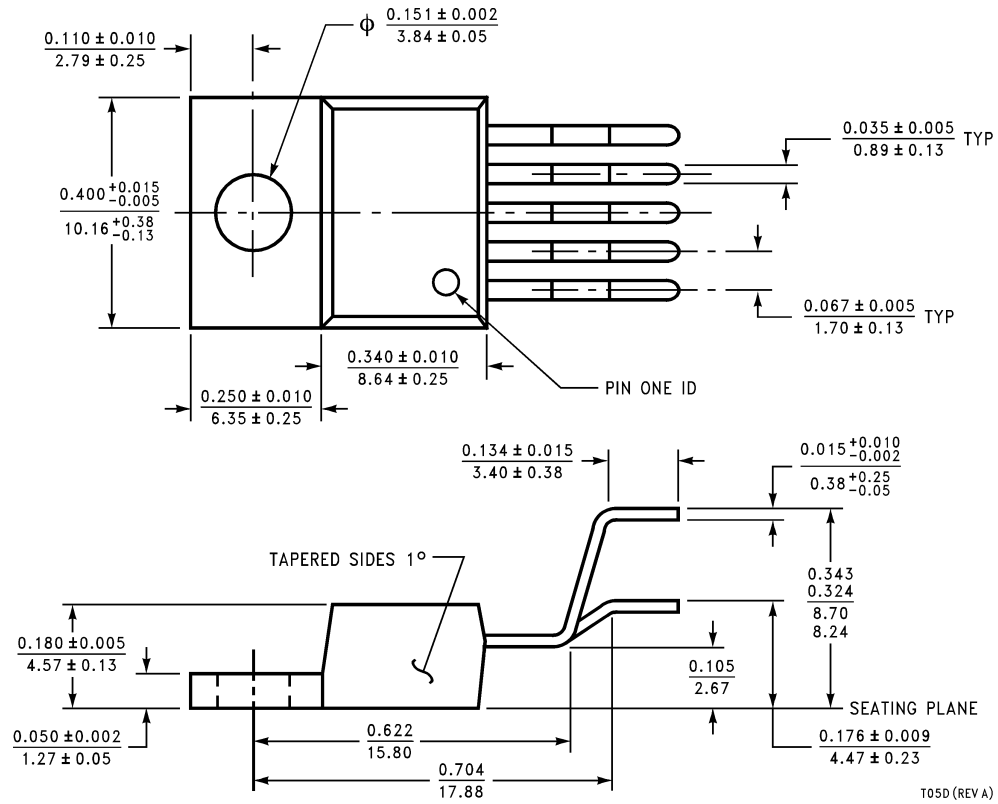
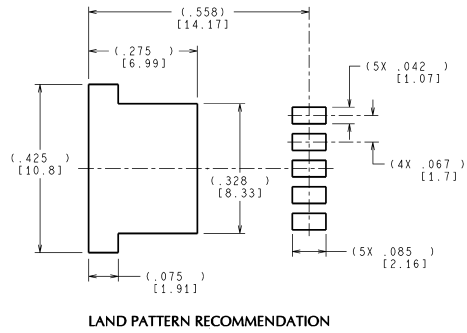
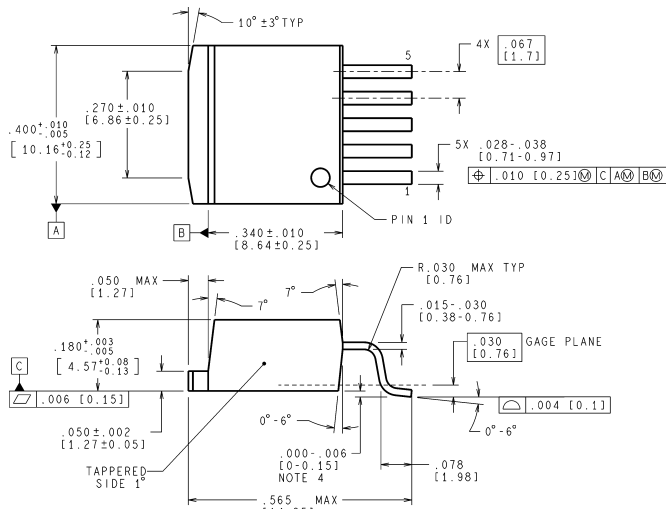

FIGURE 2. Maximum power dissipation vs ambient temperature for TO-263 package

Physical Dimensions inches (millimeters) unless otherwise noted



**TO220 5-lead, Molded, Stagger Bend Package (TO220-5)
NS Package Number T05D**



CONTROLLING DIMENSION IS INCH
VALUES IN [] ARE MILLIMETERS
DIMENSIONS IN () FOR REFERENCE ONLY

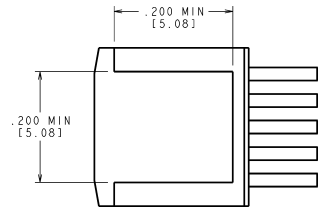

**TO263 5-Lead, Molded, Surface Mount Package (TO263-5)
NS Package Number TS5B**

TS5B (Rev D)

Notes

National does not assume any responsibility for use of any circuitry described, no circuit patent licenses are implied and National reserves the right at any time without notice to change said circuitry and specifications.

For the most current product information visit us at www.national.com.

LIFE SUPPORT POLICY

NATIONAL'S PRODUCTS ARE NOT AUTHORIZED FOR USE AS CRITICAL COMPONENTS IN LIFE SUPPORT DEVICES OR SYSTEMS WITHOUT THE EXPRESS WRITTEN APPROVAL OF THE PRESIDENT AND GENERAL COUNSEL OF NATIONAL SEMICONDUCTOR CORPORATION. As used herein:

- | | |
|----------------------------------------------------------------------------------------------------------------------------------------------------------------------------------------------------------------------------------------------------------------------------------------------------------------------------------------------------------|---------------------------------------------------------------------------------------------------------------------------------------------------------------------------------------------------------------------------------------------|
| <p>1. Life support devices or systems are devices or systems which, (a) are intended for surgical implant into the body, or (b) support or sustain life, and whose failure to perform when properly used in accordance with instructions for use provided in the labeling, can be reasonably expected to result in a significant injury to the user.</p> | <p>2. A critical component is any component of a life support device or system whose failure to perform can be reasonably expected to cause the failure of the life support device or system, or to affect its safety or effectiveness.</p> |
|----------------------------------------------------------------------------------------------------------------------------------------------------------------------------------------------------------------------------------------------------------------------------------------------------------------------------------------------------------|---------------------------------------------------------------------------------------------------------------------------------------------------------------------------------------------------------------------------------------------|

BANNED SUBSTANCE COMPLIANCE

National Semiconductor manufactures products and uses packing materials that meet the provisions of the Customer Products Stewardship Specification (CSP-9-111C2) and the Banned Substances and Materials of Interest Specification (CSP-9-111S2) and contain no "Banned Substances" as defined in CSP-9-111S2.

Leadfree products are RoHS compliant.



National Semiconductor
Americas Customer
Support Center
 Email: new.feedback@nsc.com
 Tel: 1-800-272-9959

National Semiconductor
Europe Customer Support Center
 Fax: +49 (0) 180-530 85 86
 Email: europe.support@nsc.com
 Deutsch Tel: +49 (0) 69 9508 6208
 English Tel: +44 (0) 870 24 0 2171
 Français Tel: +33 (0) 1 41 91 8790

National Semiconductor
Asia Pacific Customer
Support Center
 Email: ap.support@nsc.com

National Semiconductor
Japan Customer Support Center
 Fax: 81-3-5639-7507
 Email: jpn.feedback@nsc.com
 Tel: 81-3-5639-7560